

**Trace the lines  
and then color  
it.**

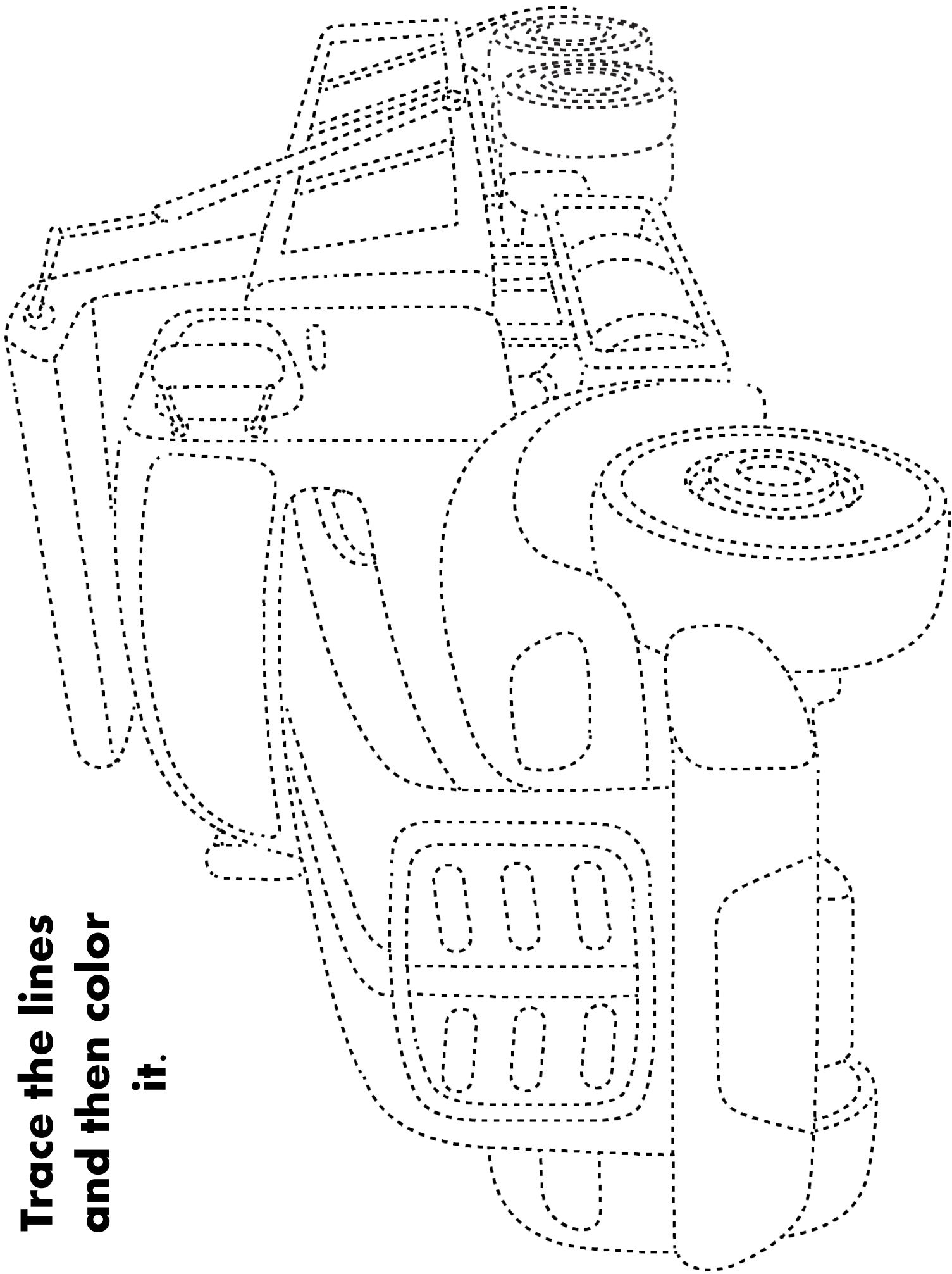

**Connect the dots  
and then color it.**

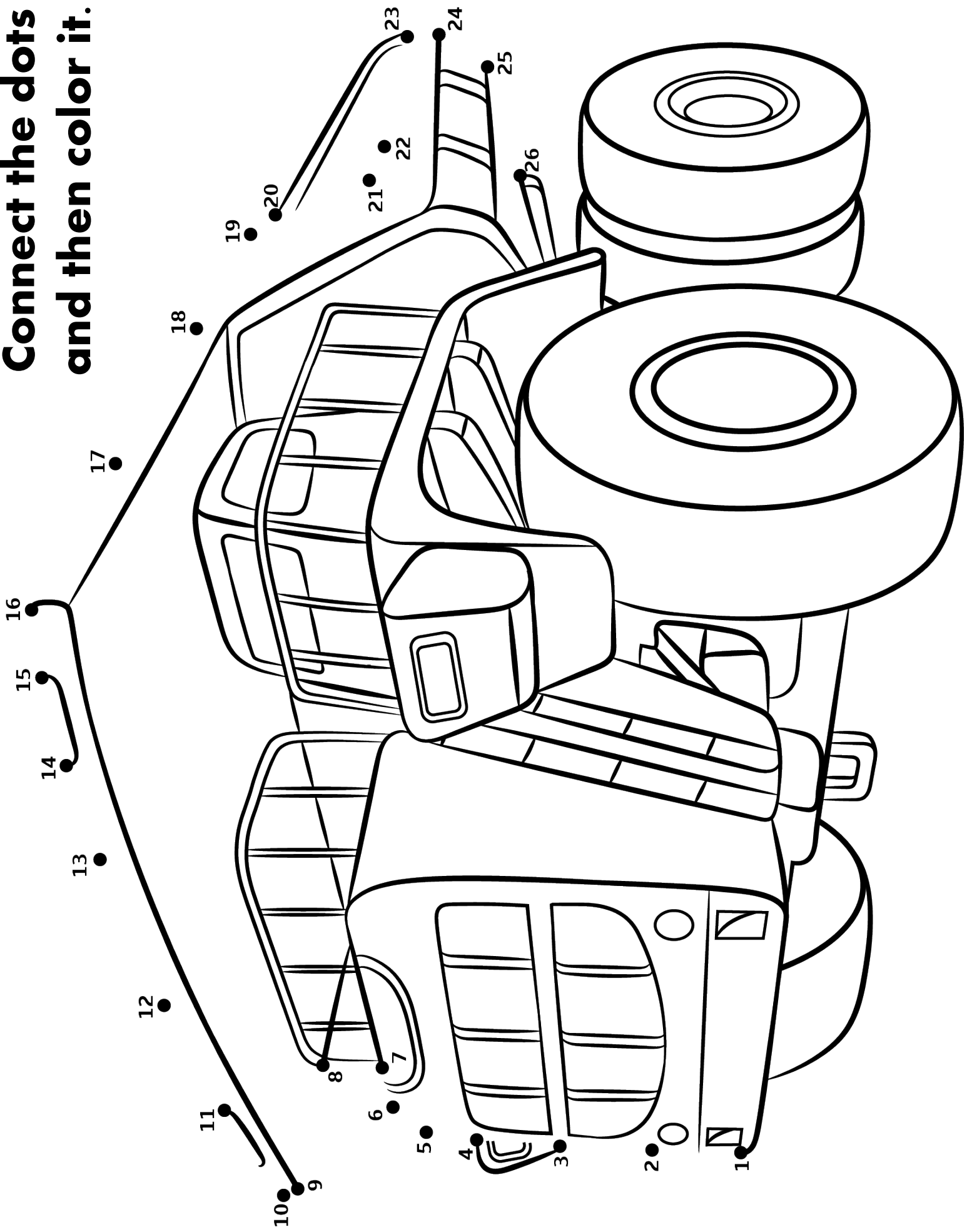

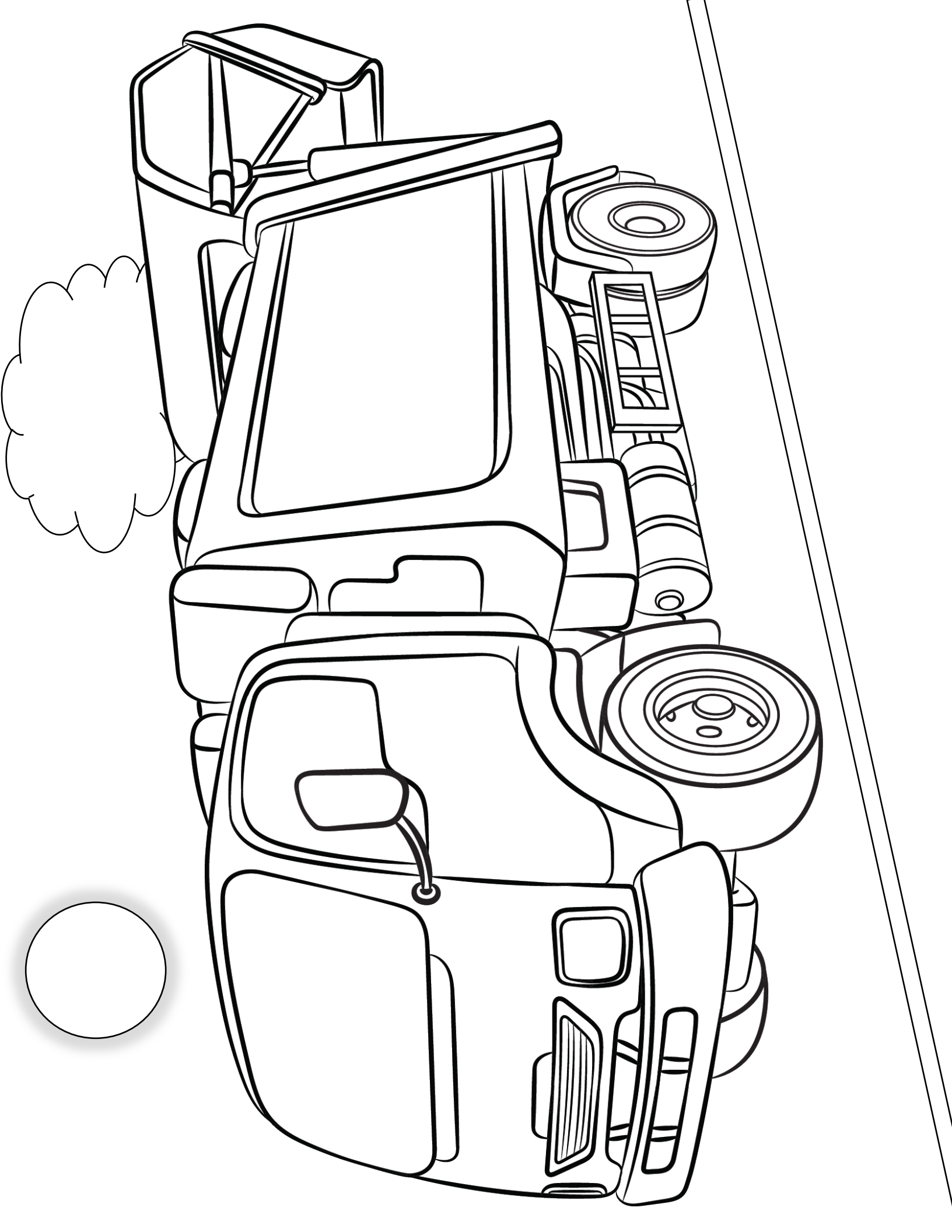

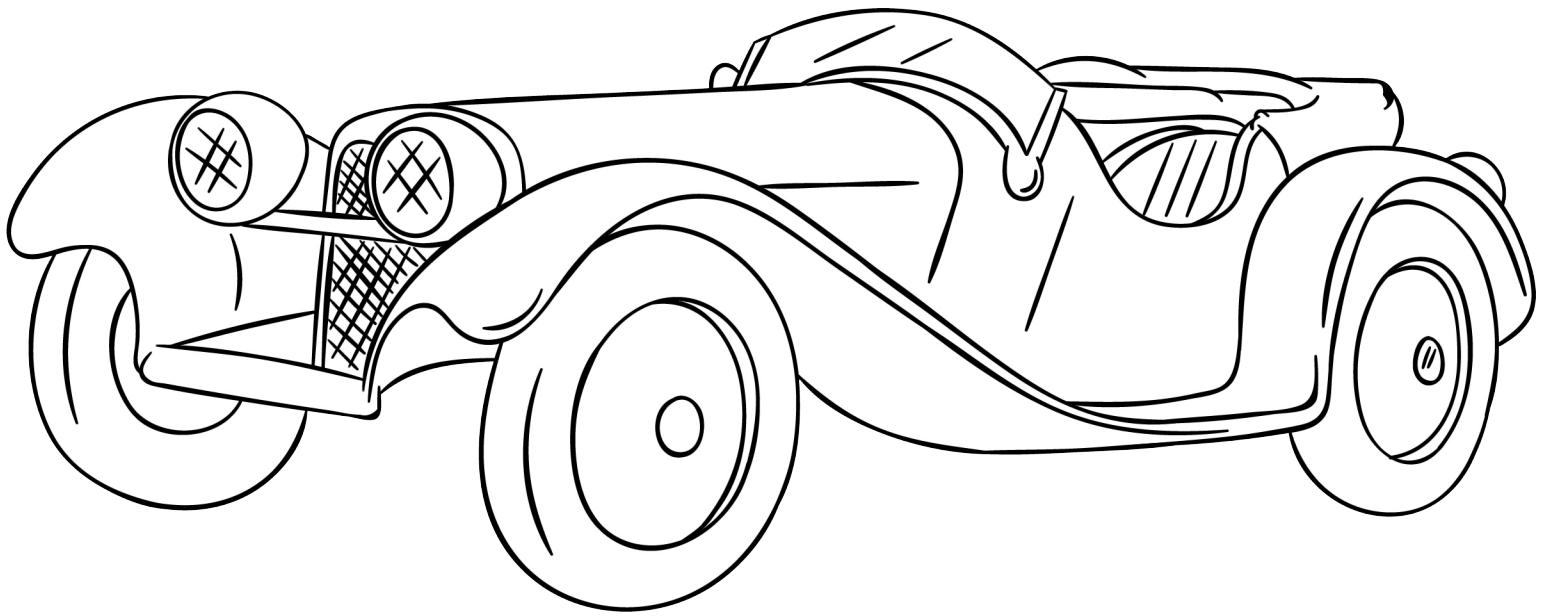



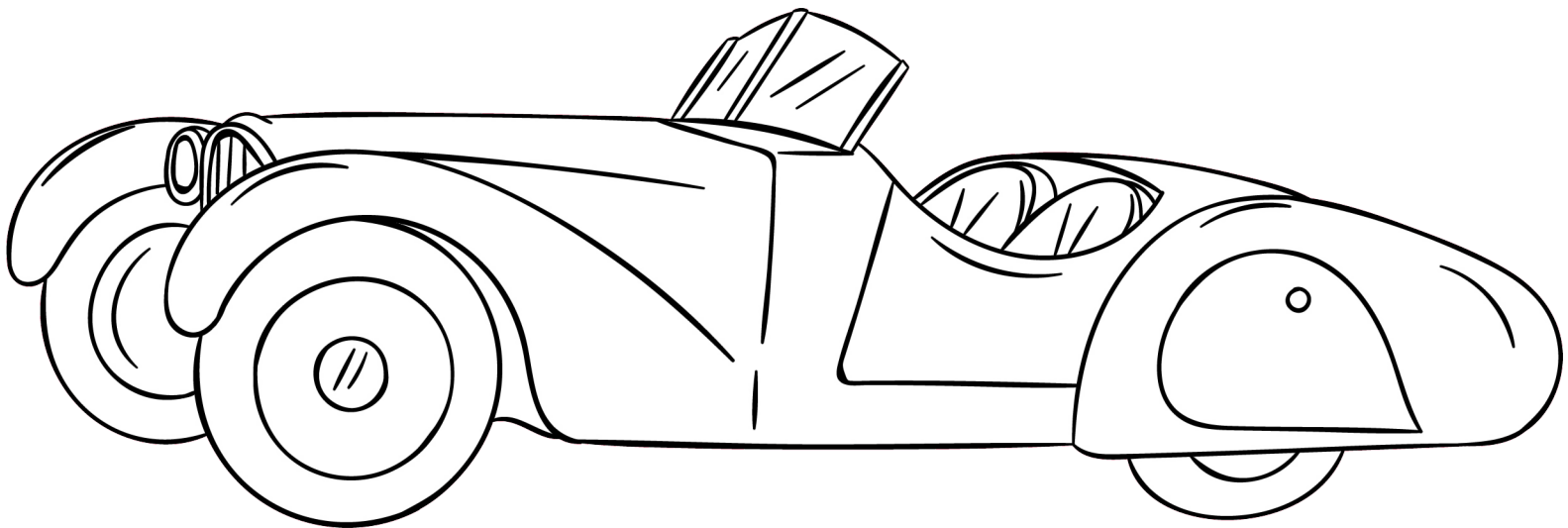

































**Which Of These Cars Do You Like Best?**



# Sudoku Puzzle 1 EASY

	<b>7</b> 							
<b>9</b> 			<b>1</b> 		<b>6</b> 		<b>2</b> 	<b>7</b> 
<b>8</b> 		<b>6</b> 		<b>2</b> 	<b>7</b> 	<b>4</b> 		<b>3</b> 
<b>3</b> 					<b>5</b> 		<b>9</b> 	<b>4</b> 
<b>5</b> 		<b>4</b> 	<b>2</b> 				<b>3</b> 	
		<b>1</b> 	<b>7</b> 	<b>3</b> 		<b>6</b> 		
	<b>2</b> 	<b>3</b> 	<b>8</b> 	<b>9</b> 		<b>5</b> 	<b>4</b> 	
<b>1</b> 		<b>9</b> 		<b>6</b> 			<b>7</b> 	
			<b>4</b> 			<b>9</b> 		

**SOLUTION IN BACK**

